

Part Number: S7902
2 ROW 

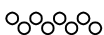
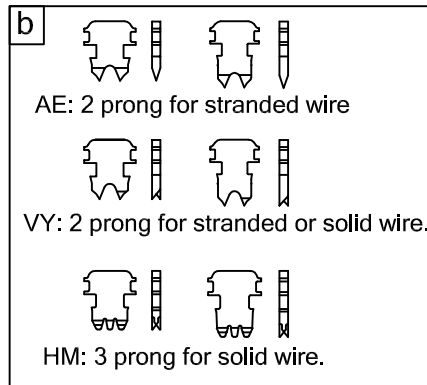
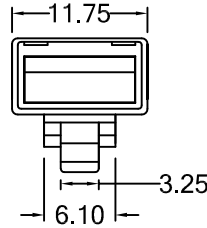
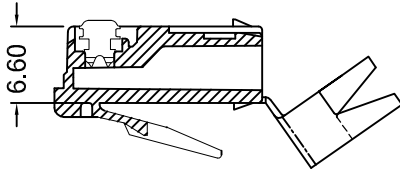
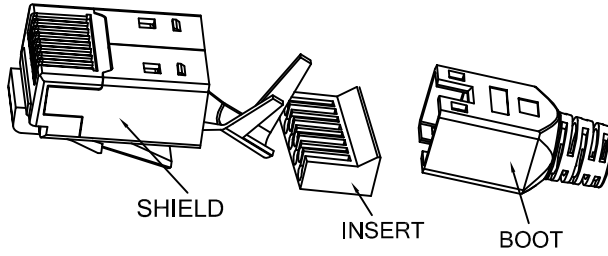
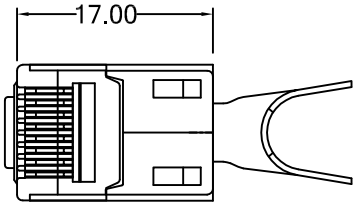

MATERIAL & FINISH

Housing and insert: PC. UL94V-2, clean
Contact: Copper alloy with gold plated.
Shield: Brass with nickel plated.
SR Boot: ABS, black or blue

ORDERING INFORMATION

S7902 A F 8 8 8 **a** **b** A + **c**

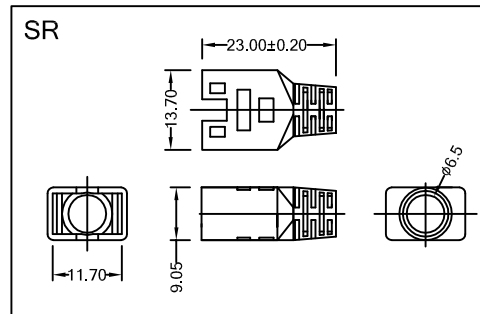
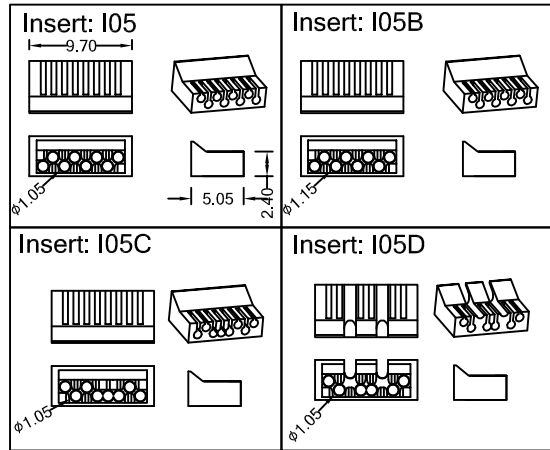
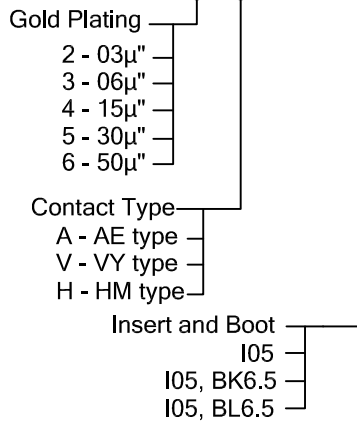

UNIT: m/m
TOL.: ±0.15 unless otherwise stated



巨亮企業有限公司
CHU LIANG ENTERPRISE CO.,LTD.
TEL:886-2-22023997 FAX:886-2-22023867

E-mail: web@plug.com.tw
peter@plug.com.tw
Web: http://www.plug.com.tw