

Part Number: S7850

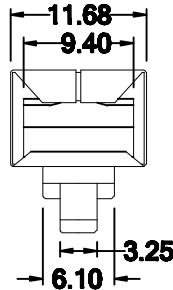
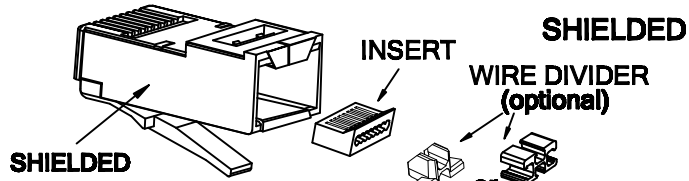
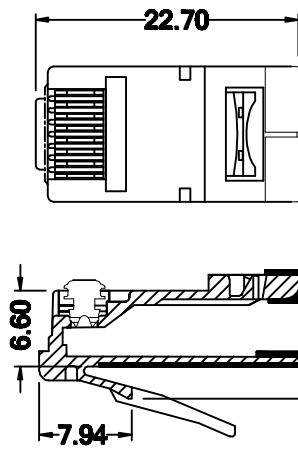

MATERIAL & FINISH

Housing & Insert: PC, UL94V-2, clean
 Contact : Copper alloy plated with gold.
 Shield: Brass with nickel plated.

MECHANICAL SPECIFICATIONS

Operating Temperature: -40°C to 85°C
 Mating Cycles: 750 cycles min.

ELECTRICAL SPECIFICATIONS

Voltage: 125 VAC
 Current: 1.5 A
 Contact Resistance: 30 milliohms max.
 Insulation Resistance: 500 megohms min.
 Dielectric Withstanding Voltage: 1000 VAC

ORDERING INFORMATION

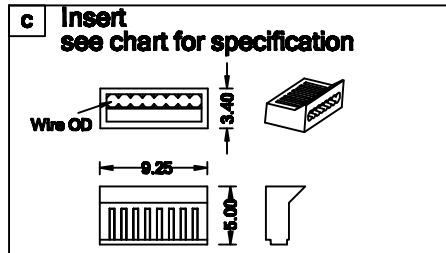
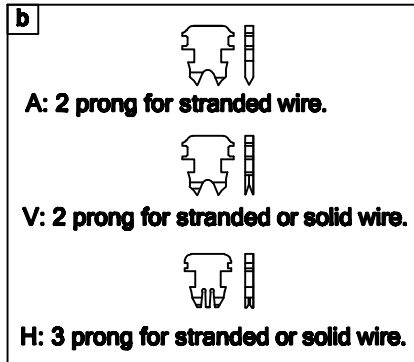
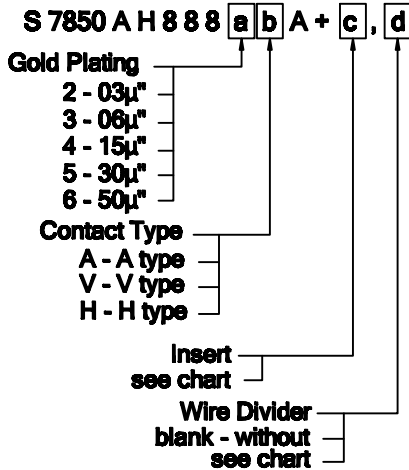

Insert Specification (Wire OD)

| wire-trim-first | | wire-push-through | |
|-----------------|--------|-------------------|--------|
| P/N | OD | P/N | OD |
| I32 | 1.02mm | I33 | 1.02mm |
| I32A | 1.10mm | I33B | 0.70mm |
| I32B | 0.95mm | I33C | 0.90mm |
| I32D | 0.60mm | | |

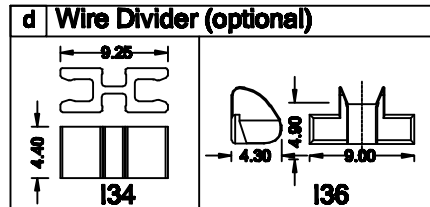

Unit: m/m
 Tol: ±0.15 unless otherwise stated



巨亮企業有限公司
 CHU LIANG ENTERPRISE CO.,LTD.
 TEL:886-2-22023997 FAX:886-2-22023867

E-mail: web@plug.com.tw
 peter@plug.com.tw
 Web: http://www.plug.com.tw