

Part Number: S7832

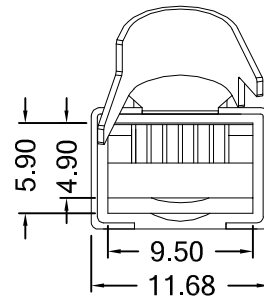
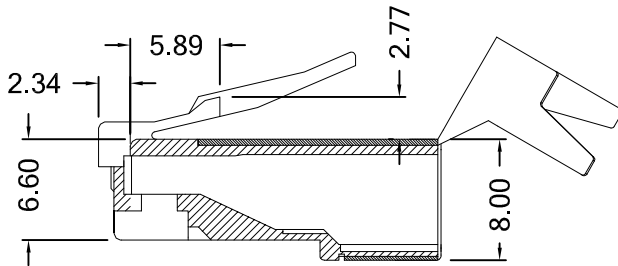
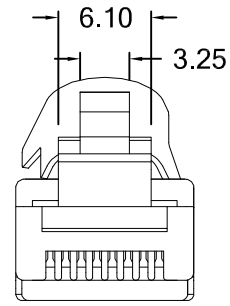
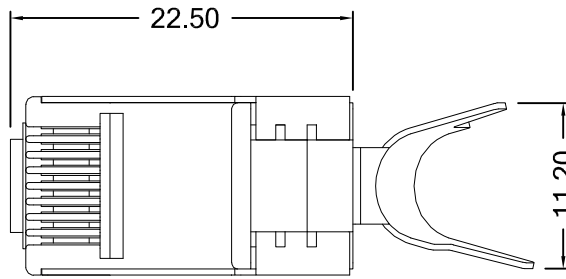

MATERIAL & FINISH

Body: PC. UL94V-2 or UL94V-0, clean
 Contact: copper alloy, underplated 100uin Nickel, and selective gold in contact region, and gold flash on remainder of terminal.

ELECTRICAL SPECIFICATIONS

Voltage: 125 VAC
 Current: 1.5 A
 Contact Resistance: 30 milliohms max.
 Insulation Resistance: 500 megaohms min.
 Dielectric Withstanding Voltage: 1000 VAC

ORDERING INFORMATION

S7832 A F 8 8 8 a b c + d

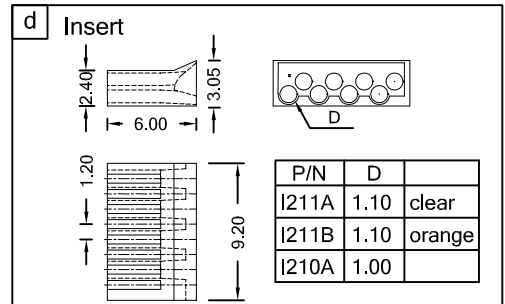
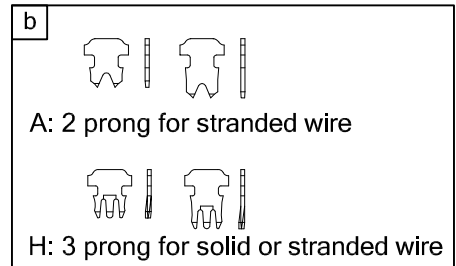
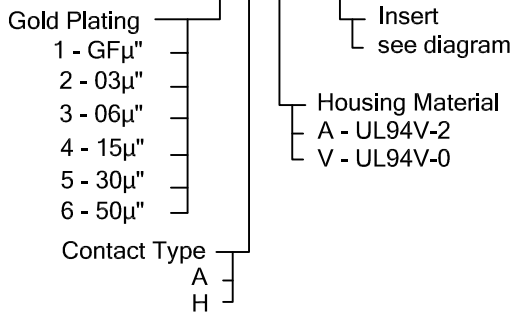

Unit: m/m

Tol.: ±0.20 unless otherwise stated



巨亮企業有限公司
 CHU LIANG ENTERPRISE CO.,LTD.

TEL:886-2-22023997 FAX:886-2-22023867

E-mail: web@plug.com.tw
 peter@plug.com.tw

Web: http://www.plug.com.tw