

Part Number: 232
Copper Plate With Mylar Inside

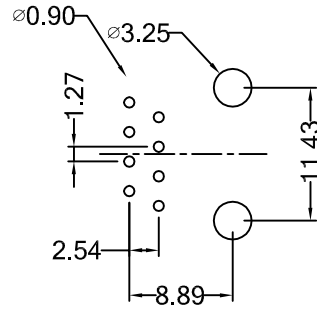

PCB LAYOUT / TOP VIEW

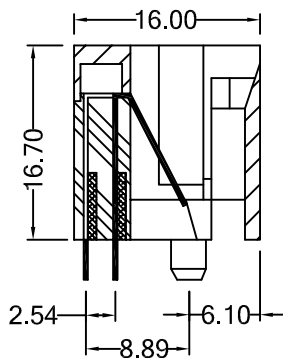
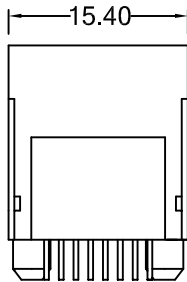
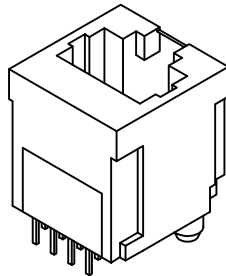
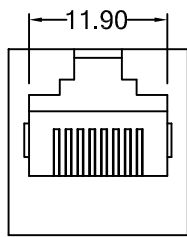
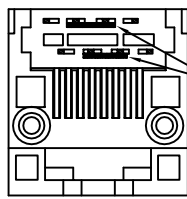

Copper Plate With Mylar

MATERIAL & FINISH

Housing & Insert: PBT. UL94V-0, black

Contact: 0.35 mm thickness phosphor bronze,
Gold plated over nickel on contact area,
Tin plated over nickel on solder area.

ORDERING INFORMATION

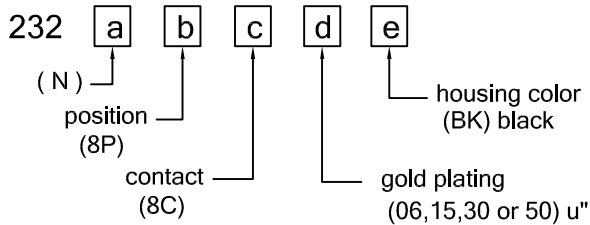

UNIT: m / m
TOL.: +/- 0.15



巨亮企業有限公司
CHU LIANG ENTERPRISE CO.,LTD.
TEL:886-2-22023997 FAX:886-2-22023867

E-mail: richard@plug.com.tw
Web: http://www.plug.com.tw